

Yokota Hi-tec

High Speed Production + High Quality Tightening

2008-2009

Impulse wrenches

System wrenches

E-wrenches

(Non-) shut-off models

Double chamber air motor

Poka Yoke⁺

Battery tools



yokota

Impulse & system wrenches

A complete program

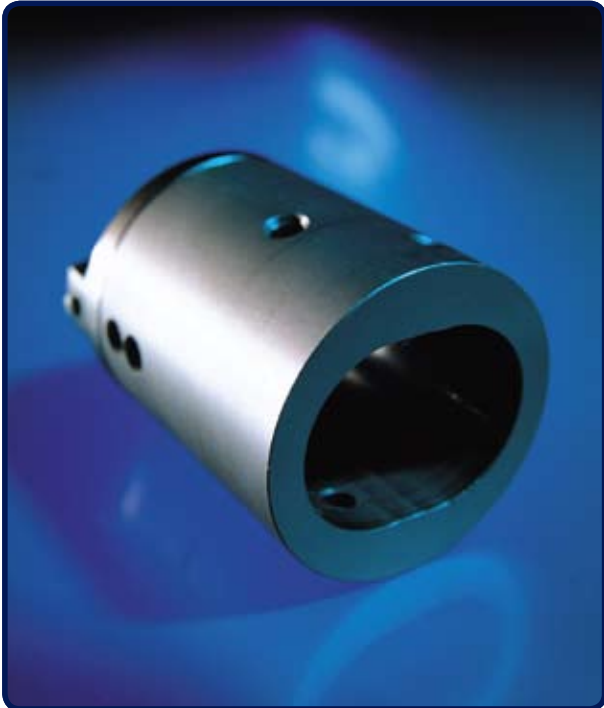

Contents



www.impulstools.com

	Page
General information	4
Impulse wrenches	5 - 7
• Double chamber air motor (Y and YLa)	
• Double chamber air motor & shut-off (Y-T)	
Battery impulse wrenches	8
• Cordless system wrenches (YBX)	
• Battery impulse wrenches (YBX)	
Poka Yoke⁺ system	9 - 10
• J-version impulse wrenches (Y and YLa)	
• Controller for J-version (YTC-3)	
Impulse wrenches	11 - 13
• Standard models - pistol (YX)	
• Standard models - straight / angle (YX)	
• Shut-off (YXS)	
Controllers	14
• For YEX / YED/TKa series (YETC-210/300)	
System wrenches	15 - 16
• Standard models (YEX)	
• Double chamber air motor (YED and TKa)	
• Controller (YETC-210 / YETC-300)	
• Accessories	
E-wrenches	17
Accessories	18 - 20
• Rubber covers	
• Various accessories	
• Service sets	
• Sleeve drive sockets	

Impulse wrenches

Application and impulse mechanism





Faster tools make assembly quicker

Yokota impulse wrenches are widely used for tightening jobs in the assembly industry, where accurate torque tolerances are necessary. Impulse tools are light, powerful, small and very importantly, have no kick-back. The Yokota range of impulse tools is increasing fast, starting at 6 Nm to tighten small joints, and goes up to 600 Nm. Evaluation of tightening processes in car assembly shows that tightening joints uses 10% of the total assembly time. Working with faster tools therefore can speed up assembly lines substantially.

A fail-safe system

Product liability is essential to carmakers. All tightened joints have to be correct. For this reason all bolted joints must be counted, documented and, of course, tightened with the right clamping force. In order to do this, you need an impulse wrench (with a built-in transducer) connected to a controller. If the controller establishes that the tightened joints do not meet the specifications, it can give a line-stop signal and the joints have to be checked manually. This fail-safe system fits perfectly in the **Poka Yoke Strategy**.

High repeatability

Impulse wrenches have a twin blade impulse mechanism for sealing oil which gives a high repeatability. The mechanism is designed so that the liner, rotated by the air motor gives an equal torque on both blades and instant rotation torque on the mainshaft (see figure below). A by-pass is designed in the liner so that the oil can escape from the area of high pressure to the area of low pressure at the moment of creating a pulse and the amount of oil flow can be adjusted by the relief valve to control the torque output. Depending on model and setting, the impulse wrenches give 10 - 40 impulses per second. The power is transmitted by oil pressure and therefore the impulse wrenches have a very low noise- and vibration level

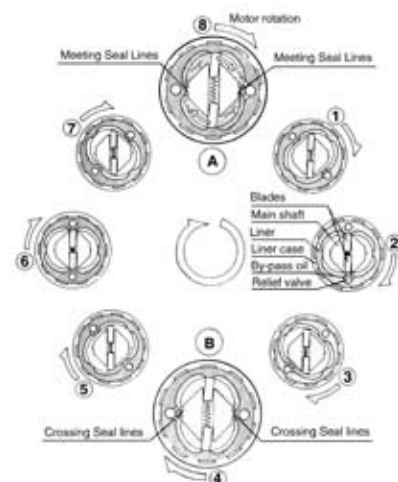

Impulse wrenches

New series Double chamber air motor, lightweight



Type	Square / Hex drive	Bolt capacity mm	RPM	Torque Nm*	Air consumption l/sec	Weight kg	Inlet thread	Hose diameter mm	Dimensions A mm	Dimensions B mm	Vibration m/s ²	Noise-level dB(A)
YLa70A	1/4" Hex	6 - 8	7.000	20 - 28	5,5	0,8	PT 1/4"	6,5	132	22	1,4	74
YLa80A	1/4" Hex	8	7.000	24 - 35	5,8	0,9	PT 1/4"	6,5	139	22	1,2	75
YLa70E	3/8" Sq.	6 - 8	7.000	20 - 35	5,5	0,8	PT 1/4"	6,5	132	22	1,4	74
YLa80E	3/8" Sq.	8	7.000	33 - 50	5,8	0,9	PT 1/4"	6,5	139	22	1,2	75
YLa90E	3/8" Sq.	8 - 10	6.500	47 - 70	6,7	1,0	PT 1/4"	9,5	148	24	1,2	78
YLa110E	1/2" Sq.	10 - 12	6.000	65 - 105	9,6	1,4	PT 1/4"	9,5	164	26	1,8	81
YLa120E	1/2" Sq.	12	6.600	80 - 130	10	1,8	PT 1/4"	9,5	172	28	2,2	82
YLa140E	1/2" Sq.	14	6.000	100 - 160	13	2,2	PT 1/4"	9,5	190	30	2,4	84

System impulse wrenches (see page 16)

TKa60A	1/4" Hex	6	6.000	10 - 16	4,5	1,3	PT 1/4"	6,5	179	22	2,1	71
TKa70A	1/4" Hex	6 - 8	7.000	20 - 27	5,3	1,3	PT 1/4"	6,5	179	22	2,1	75
TKa80A	1/4" Sq.	8	7.000	24 - 33	5,3	1,3	PT 1/4"	6,5	186	22	2,1	73
TKa60	3/8" Sq.	6	6.000	14 - 20	4,5	1,3	PT 1/4"	6,5	179	22	2,1	71
TKa70	3/8" Sq.	6 - 8	7.000	20 - 35	5,3	1,3	PT 1/4"	6,5	179	22	2,1	75
TKa80	3/8" Sq.	8	7.000	32 - 46	5,3	1,3	PT 1/4"	6,5	186	22	2,1	73
TKa90	3/8" Sq.	8 - 10	6.500	47 - 70	6,8	1,5	PT 1/4"	9,5	195	24	2,1	78
TKa110	1/2" Sq.	10 - 12	6.000	65 - 105	8,8	1,9	PT 1/4"	9,5	210	26	2,2	80
TKa120	1/2" Sq.	12	5.900	85 - 130	10	2,4	PT 1/4"	9,5	223	28	2,2	82
TKa140	1/2" Sq.	14	5.200	100 - 160	13	2,9	PT 1/4"	9,5	235	30	2,2	84
TKa150	1/2" Sq.	14 - 16	4.200	150 - 220	13	3,4	PT 1/4"	9,5	241	32	2,4	84

- No lube air motor to protect the environment
- Extended oil change intervals (new impulse mechanism design)
- Lightweight
- Low air consumption, high efficiency air motor
- High durability, due to improved air motor design features, with special patented air motor vanes
- Improved ergonomic design
- Low noise and vibration levels
- Low trigger-force

* Torque specifications

All specified torques are measured on the Yokota testers, series YET, at a dynamic airpressure of 0.63MPa. The Yokota testers have a static transducer, the specified torques are therefore to be used as a guidance only. In general the torque range will be lower in case of using lower airpressure, extension bars, torx or hexagon inset sockets, soft joints, etc.



Tailor-made tool:
YEX-150S with crowfoot



Tailor-made tool:
Y-70E with crowfoot

Accessories for impulse wrenches on pages 18 - 20.

Tailor-made tools! Please inform us about your specific request and we will make a suitable solution.

Double chamber air motor



Y-41A
Y-46E/A
Y-56E/A
Y-61E/A



Y-70
Y-90E



Y-100E
Y-130E
Y-140

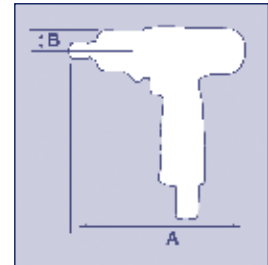

Double chamber air motor

Type	Square / Hex drive	Bolt capacity mm	RPM	Torque Nm**	Air consumption l/sec	Weight kg	Inlet thread	Hose diameter mm	Dimensions A mm B mm	Vibration m/s ²	Noise-level dB(A)
Y-40SA*	1/4" Hex	4 - 6	10.000	6 - 12	5,0	0,84	PT 1/4"	6,5	229 17	4,6	69
Y-41A	1/4" Hex	4 - 6	9.300	6 - 12	5,0	0,73	PT 1/4"	6,5	141 17	2,1	72
Y-46E	3/8" Sq.	5 - 6	8.000	16 - 30	5,8	0,87	PT 1/4"	9,5	158 18	1,0	80
Y-46A	1/4" Hex	5 - 6	8.000	16 - 26	5,8	0,87	PT 1/4"	9,5	158 18	1,0	80
Y-56E	3/8" Sq.	6 - 8	7.000	25 - 47	6,6	0,87	PT 1/4"	9,5	144 21	1,0	80
Y-56A	1/4" Hex	6 - 8	7.000	22 - 33	6,6	0,87	PT 1/4"	9,5	144 21	1,0	80
Y-61E	3/8" Sq.	6 - 8	5.500	34 - 54	6,6	0,96	PT 1/4"	9,5	155 21	1,0	74
Y-61A	1/4" Hex	6 - 8	5.500	27 - 41	6,6	0,96	PT 1/4"	9,5	155 21	1,0	74
Y-70	3/8" Sq.	8 - 10	5.500	44 - 72	7,5	1,40	PT 1/4"	9,5	170 25	2,0	75
Y-90E	1/2" Sq.	10 - 12	5.000	78 - 116	8,3	1,85	PT 1/4"	9,5	177 30	1,5	72
Y-100E	1/2" Sq.	12	5.000	100 - 145	11,8	2,00	PT 1/4"	12,7	188 32,5	2,1	80
Y-130E	1/2" Sq.	14	3.500	140 - 220	12,8	2,50	PT 1/4"	12,7	201 34	2,2	83
Y-140	3/4" Sq.	16	3.300	160 - 270	13,1	3,20	PT 1/4"	12,7	226 36	3,3	82

* The Y-40SA is a straight model, all other types are pistol models.



Y-40SA

** Torque specifications

All specified torques are measured on the Yokota testers, series YET, at a dynamic airpressure of 0.63MPa. The Yokota testers have a static transducer, the specified torques are therefore to be used as a guidance only. In general the torque range will be lower in case of using lower airpressure, extension bars, torx or hexagon inset sockets, soft joints, etc.

For information about sleeve drive sockets please see page 18.

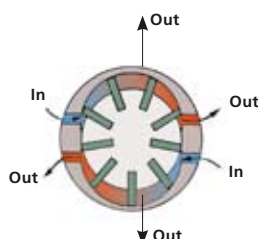

The Yokota Y-, YLa, YED- and TKa-series impulse wrenches with double chamber air motor reach the required torque very quickly. The tools have a high number of impulses per second, and therefore very accurate torques can be realized, resulting in increased production speed

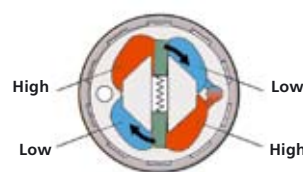

Patented twin blade impulse unit. Yokota's unique impulse mechanism reduces noise and vibration! High impulse frequency.

Impulse wrenches

Double chamber air motor with shut-off



Y-T40A
Y-T45E/A
Y-T55E/A



Y-T70E
Y-T90E

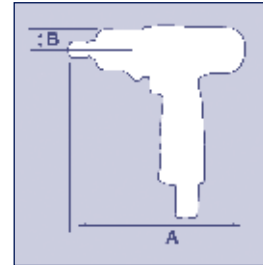

Double chamber air motor with shut-off

Type	Square / Hex drive	Bolt capacity mm	RPM	Torque Nm*	Air consumption l/sec	Weight kg	Inlet thread	Hose diameter mm	Dimensions		Vibration m/s ²	Noise-level dB(A)
									A mm	B mm		
Y-T40A	1/4" Hex	4 - 5	6.000	8 - 13	6,0	0,95	PT 1/4"	6,5	182	18,5	2,2	82
Y-T45E	3/8" Sq.	6	7.000	17 - 25	5,8	1,10	PT 1/4"	9,5	187	21	1,6	74
Y-T45A	1/4" Hex	6	7.000	15 - 20	5,8	1,10	PT 1/4"	9,5	187	21	1,6	74
Y-T55E	3/8" Sq.	6 - 8	6.000	25 - 38	5,8	1,12	PT 1/4"	9,5	187	21	2,3	75
Y-T55A	1/4" Hex	6 - 8	6.000	20 - 30	5,8	1,12	PT 1/4"	9,5	187	21	2,3	75
Y-T70E	3/8" Sq.	10	5.500	40 - 55	6,6	1,50	PT 1/4"	9,5	207	25	2,1	82
Y-T90E	1/2" Sq.	10 - 12	5.000	60 - 90	7,5	1,90	PT 1/4"	9,5	200	31	1,5	85

* Torque specifications

All specified torques are measured on the Yokota testers, series YET, at a dynamic airpressure of 0.63MPa. The Yokota testers have a static transducer, the specified torques are therefore to be used as a guidance only. In general the torque range will be lower in case of using lower airpressure, extension bars, torx or hexagon inset sockets, soft joints, etc.

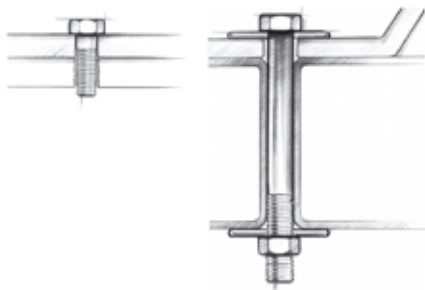

In order to get full benefit of all the advantage of impulse wrenches, it is most important that the correct tool is used for the correct application. Each joint has its own characteristics. Please ask us to help you to select the right tool for your application.

Accessories for impulse wrenches on pages 18 - 20.

Rubber protection covers for all Y and Y-T impulse wrenches are included in the box.

Cordless system wrenches

Battery impulse wrenches



YBX-600TE



YBX-600TE Battery



YBX-50A/E



YBX-50 Charger

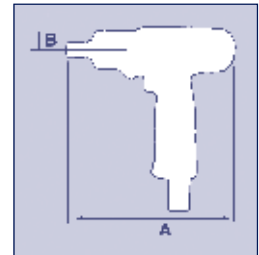

Cordless system wrench

Type	Square / Hex drive	Bolt capacity mm	RPM	Torque Nm*	Weight kg	Dimensions		Vibration m/s ²	Noise-level dB(A)
						A mm	B mm		
YBX-600TE	3/8" Sq.	M6	2.000	8 - 20	1,5	170	37	< 2,5	77
YBX-600TA	1/4" Hex.	M6	2.000	7 - 18	1,5	170	37	< 2,5	77
YBX-800TE	3/8" Sq.	M8	2.000	18 - 35	1,55	174	37	< 2,5	78
YBX-800TA	1/4" Hex.	M8	2.000	16 - 31	1,55	174	37	< 2,5	78

Battery impulse wrenches

Type	Square / Hex drive	Bolt capacity mm	RPM	Torque Nm*	Weight kg	Dimensions		Vibration m/s ²	Noise-level dB(A)
						A mm	B mm		
YBX-50A	1/4" Hex	5 - 8	2.200	7 - 22	1,7	194	26	3	79
YBX-50E	3/8" Sq.	5 - 8	2.200	7 - 22	1,7	194	26	3	79

* Torque specifications

All specified torques are measured on the Yokota testers, series YET, at a dynamic airpressure of 0.63MPa. The Yokota testers have a static transducer, the specified torques are therefore to be used as a guidance only. In general the torque range will be lower in case of using lower airpressure, extension bars, torx or hexagon inset sockets, soft joints, etc.

YBX-600T/800T: cordless system wrench. Electronic controlled battery impulse wrench with built-in rotary encoder, resulting in very high torque accuracy. Shut-off is calculated over multiple impulses. The controller for counting joints, Poka Yoke is built-in.

Battery YBX-600T/800T: Lithium-ion.

Battery YBX-50A/E: standard or with LED-indication. Chargers for 105 minutes can be supplied (see page 19). Multiple charger on request.

Accessories for impulse wrenches on pages 18 - 20.



YBX-600TE in use



Tightening: OK

Poka Yoke+ system

Critical tightening



YLa 90E-JQ



Y-90E-JQ



YTC-3

Poka Yoke+ system

Type	Square / Hex drive	Bolt capacity mm	RPM	Torque Nm*	Air consumption l/sec	Weight kg	Inlet thread	Hose diameter mm	Dimensions A mm	B mm	Vibration m/s ²	Noise-level dB(A)
Y-41A-JQ	1/4" Hex	4 - 6	9.300	6 - 12	5,0	0,73	PT 1/4"	6,5	141	17	2,1	72
Y-46E-JQ	3/8" Sq.	5 - 6	8.000	16 - 30	5,8	0,87	PT 1/4"	9,5	158	18	1,0	80
Y-56E-JQ	3/8" Sq.	6 - 8	7.000	25 - 47	6,6	0,87	PT 1/4"	9,5	144	21	1,0	80
Y-61E-JQ	3/8" Sq.	6 - 8	5.500	34 - 54	6,6	0,96	PT 1/4"	9,5	155	21	1,0	74
Y-70-JQ	3/8" Sq.	8 - 10	5.500	44 - 72	7,5	1,40	PT 1/4"	9,5	170	25	2,0	75
Y-90E-JQ	1/2" Sq.	10 - 12	5.000	78 - 116	8,3	1,85	PT 1/4"	9,5	177	30	1,5	72
Y-100E-JQ	1/2" Sq.	12	5.000	100 - 145	11,8	2,00	PT 1/4"	12,7	188	32,5	2,1	80
Y-130E-JQ	1/2" Sq.	14	3.500	140 - 220	12,8	2,50	PT 1/4"	12,7	201	34	2,2	83
Y-140-JQ	3/4" Sq.	16	3.300	160 - 270	13,1	3,20	PT 1/4"	12,7	226	36	3,3	82

New lightweight series

YLa 70 A-JQ	1/4" Hex	6 - 8	7.000	20 - 28	5,5	0,80	PT 1/4"	6,9	132	22	1,4	74
YLa 70 E-JQ	3/8" Sq.	6 - 8	7.000	20 - 35	5,5	0,80	PT 1/4"	6,5	132	22	1,4	74
YLa 80 A-JQ	1/4" Hex	8	7.000	24 - 35	5,8	0,90	PT 1/4"	6,5	139	22	1,2	75
YLa 80 E-JQ	3/8" Sq.	8	7.000	33 - 50	5,8	0,90	PT 1/4"	6,5	139	22	1,2	75
YLa 90 E-JQ	3/8" Sq.	8 - 10	6.500	47 - 70	6,7	1,00	PT 1/4"	9,5	148	24	1,2	78
YLa 110 E-JQ	1/2" Sq.	10 - 12	6.000	65 - 105	9,6	1,40	PT 1/4"	9,5	164	26	1,8	81
YLa 120 E-JQ	1/2" Sq.	12	6.600	80 - 130	10	1,80	PT 1/4"	9,5	172	28	2,2	82
YLa 140 E-JQ	1/2" Sq.	14	6.000	100 - 160	13	2,20	PT 1/4"	9,5	190	30	2,4	84

* Torque specifications

All specified torques are measured on the Yokota testers, series YET, at a dynamic airpressure of 0.63MPa. The Yokota testers have a static transducer, the specified torques are therefore to be used as a guidance only. In general the torque range will be lower in case of using lower airpressure, extension bars, torx or hexagon inset sockets, soft joints, etc.

System features

- Group control
- Controlled shut-off
- Double tightening detection
- Interlock with assembly line
- Error judgement on trigger release
- Teach-in mode for programming
- Oil deterioration indication

Controller YTC-3

- Power supply: 100 - 240V AC
- Input: 8
- Relay output: 4
- opening and shutting capacity:
- Max. DC-48W, AC-220VA)
- Output for solenoid valve: 1(DC24V 2W)

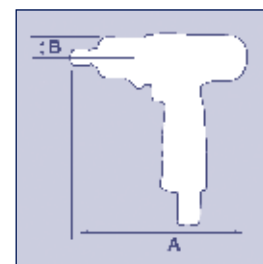



Y-70-JQ
Y-90E-JQ
Y-100E-JQ
Y-130E-JQ
Y-140-JQ

Y-41A-JQ
Y-46E-JQ
Y-56E-JQ
Y-61E-JQ

Poka Yoke+: functioning principle

The system is controlled by measuring the air pressure at the inlet side of the air motor. This air pressure varies from free running to impulsing. By this measured air pressure the controller detects contact of the bolt head (point 2). Upon contact, the adjustable timer gives the shut-off signal (point 3). Adjustability of the timer takes care of adoption to either hard or soft joints. Similar, the controller detects double hits and trigger release before shut-off.

Superior clampforces

In conventional shut-off tools point 2 is the shut-off point. Due to the above mentioned principle of the Poka Yoke+ controller, the relaxation is minimized and the correct torque and clampforce are achieved. The torque is adjusted at the impulse mechanism. In combination with the parameters in the controller YTC-3, a reliable shut-off is achieved.

The whole system is more accurate than shut-off or standard impulse wrenches.

Typical air pressure curve of the impulse wrench

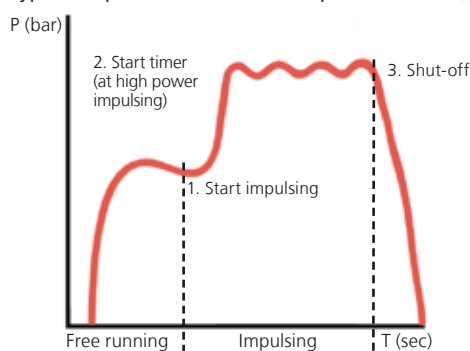

Impulse wrenches

Pistol models



Pistol models

Type	Square / Hex drive	Bolt capacity mm	RPM	Torque Nm*	Air consumption l/sec	Weight kg	Raccord pneum.	Inlet thread	Dimensions A mm B mm		Vibration m/s ²	Noise-level dB(A)
YX-180E	3/8" Sq.	4 - 6	10.500	19 - 31	4,2	1,00	PT 1/4"	6	169	23	3	72
YX-180A	1/4" Hex	4 - 6	10.500	18 - 30	4,2	1,00	PT 1/4"	6	169	23	3	72
YX-280E	3/8" Sq.	6 - 8	10.500	25 - 38	5,0	1,02	PT 1/4"	6	180	23	2	70
YX-280A	1/4" Hex	6 - 8	10.500	20 - 34	5,0	1,02	PT 1/4"	6	180	20	2	70
YX-380E	3/8" Sq.	8	10.000	34 - 47	5,0	1,24	PT 1/4"	6	180	25	2,1	75
YX-380A	1/4" Hex	6 - 8	10.000	29 - 44	5,0	1,24	PT 1/4"	6	180	25,5	2,1	75
YX-500E	3/8" Sq.	8 - 10	8.200	31 - 55	5,8	1,40	PT 1/4"	6	173	26,5	2	68
YX-700E	3/8" Sq.	8 - 10	8.000	45 - 78	6,7	1,60	PT 1/4"	9	185	26,5	2	68
YX-900E	1/2" Sq.	10	6.500	70 - 111	6,7	2,00	PT 1/4"	9	201	30,5	2	72
YX-1100E	1/2" Sq.	10 - 12	4.700	85 - 123	7,5	2,20	PT 1/4"	9	210	30,5	2,5	72
YX-1400E	1/2" Sq.	12 - 14	6.000	102 - 148	8,3	2,70	PT 1/4"	9	214	33,5	2,6	78
YX-1900E	1/2" Sq.	12 - 14	5.800	140 - 201	8,3	3,40	PT 1/4"	9	224	35,5	3	79
YX-2400E	1/2" Sq.	14 - 16	4.200	175 - 279	9,2	4,10	PT 1/4"	9	236	37,0	5,3	77
YX-3000	3/4" Sq.	16 - 18	4.700	200 - 304	10,0	4,60	PT 1/4"	12,7	246	40,0	3,9	80
YX-4500	3/4½ Sq.	18 - 20	3.400	392 - 490	11,6	9,80	PT 3/8"	12,7	300	65,0	3,9	87

* Torque specifications

All specified torques are measured on the Yokota testers, series YET, at a dynamic airpressure of 0.63MPa. The Yokota testers have a static transducer, the specified torques are therefore to be used as a guidance only. In general the torque range will be lower in case of using lower airpressure, extension bars, torx or hexagon inset sockets, soft joints, etc.

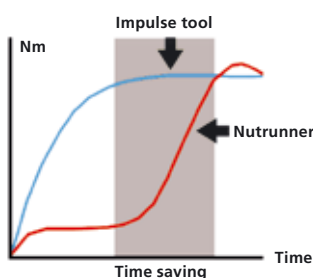

Save time - save money

Because of the principal of using hydraulics to reach a certain torque, impulse tools can run at a high rpm. The required torque is reached in a split second. All Yokota impulse wrenches can be used for hard and soft joints, and give a high accuracy / repeatability and a low relaxation.

Straight / Angle models



YX-180SE/A
YX-280SE/A
YX-380SE/A
YX-500SE
YX-700SE



YX-280C
YX-500C
YX-700C

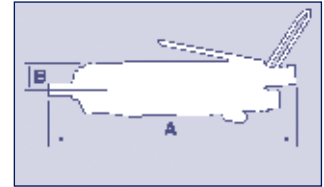

D (YX-280C) = 50 mm
D (YX-500C) = 66 mm
D (YX-700C) = 70 mm

Straight models

Type	Square / Hex drive	Bolt capacity mm	RPM	Torque Nm*	Air consumption l/sec	Weight kg	Inlet thread.	Hose diameter mm	Dimensions A mm B mm		Vibration m/s ²	Noise-level dB(A)
YX-180SE	3/8" Sq.	4 - 6	10.500	19 - 31	4,2	0,96	PT 1/4"	6	220	23	3,3	73
YX-180SA	1/4" Hex	4 - 6	10.500	18 - 30	4,2	0,96	PT 1/4"	6	220	23	3,3	73
YX-280SE	3/8" Sq.	6 - 8	10.500	25 - 38	5,0	1,02	PT 1/4"	6	232	23	4	73
YX-280SA	1/4" Hex	6	10.500	20 - 34	5,0	1,02	PT 1/4"	6	232	23	4	73
YX-380SE	3/8" Sq.	8	10.000	32 - 47	5,0	1,18	PT 1/4"	6	232	25,5	3,3	75
YX-380SA	1/4" Hex	6 - 8	10.000	29 - 44	5,0	1,18	PT 1/4"	6	232	25,5	3,3	75
YX-500SE	3/8" Sq.	8 - 10	7.500	31 - 55	5,0	1,25	PT 1/4"	6	241	25,5	6,6	74
YX-700SE	3/8" Sq.	8 - 10	5.000	35 - 62	5,8	1,50	PT 1/4"	9	262	26,5	6,6	72

Angle models

Type	Square / Hex drive	Bolt capacity mm	RPM	Torque Nm*	Air consumption l/sec	Weight kg	Inlet thread.	Hose diameter mm	Dimensions A mm B mm		Vibration m/s ²	Noise-level dB(A)
YX-280C	3/8" Sq.	4 - 6	10.000	15 - 24	5,0	1,40	PT 1/4"	6	257	16,0	4	83
YX-500C	3/8" Sq.	6 - 8	7.500	30 - 45	5,0	1,50	PT 1/4"	6	266	18,0	10	73
YX-700C	3/8" Sq.	8 - 10	5.000	36 - 50	5,8	1,80	PT 1/4"	9	289	18,0	8,6	72

* Torque specifications

All specified torques are measured on the Yokota testers, series YET, at a dynamic airpressure of 0.63MPa. The Yokota testers have a static transducer, the specified torques are therefore to be used as a guidance only. In general the torque range will be lower in case of using lower airpressure, extension bars, torx or hexagon inset sockets, soft joints, etc.

For all impulse wrenches quick change couplings - 7/16" hex are available. You can choose out of 2 sizes:
* DO9938-0-100 for 3/8" square drive
* DO9912-0-100 for 1/2" square drive

Accessories for impulse wrenches on pages 18 - 20.

Impulse wrenches

Shut-off

YXS-500E
YXS-700E
YXS-900E



YXS-1100E
YXS-1900E

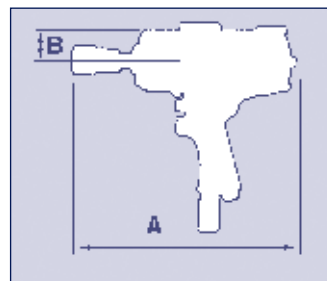

Impulse wrenches with shut-off

Type	Square / Hex drive	Bolt capacity mm	RPM	Torque Nm*	Air consumption l/sec	Weight kg	Inlet thread	Hose diameter mm	Dimensions		Vibration m/s ²	Noise-level dB(A)
									A mm	B mm		
YXS-500E	3/8" Sq.	8 - 10	8.200	30 - 50	6,0	1,74	PT 1/4"	6	199	35	2	68
YXS-700E	3/8" Sq.	8 - 10	8.000	45 - 70	6,6	1,94	PT 1/4"	9	211	36	1,6	68
YXS-900E	1/2" Sq.	10	6.500	65 - 101	6,6	2,45	PT 1/4"	9	227	40	2	72
YXS-1100E	1/2" Sq.	10 - 12	4.700	80 - 110	7,5	2,50	PT 1/4"	9	237	40	3	76
YXS-1900E	1/2" Sq.	12 - 14	5.800	100 - 160	8,3	3,90	PT 1/4"	9	259	46,5	2,4	79

Note: All YXS impulse wrenches are pistol models.

* Torque specifications

All specified torques are measured on the Yokota testers, series YET, at a dynamic airpressure of 0.63MPa. The Yokota testers have a static transducer, the specified torques are therefore to be used as a guidance only. In general the torque range will be lower in case of using lower airpressure, extension bars, torx or hexagon inset sockets, soft joints, etc.

Accessories for impulse wrenches on pages 18 - 20.

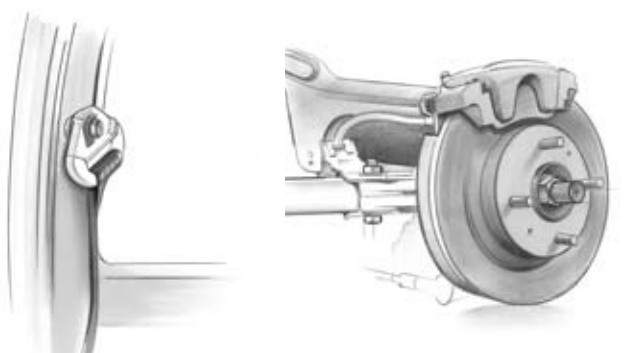

Bolt / torque control

Electronic control for YEX-, YED- and TKa series



YETC-210

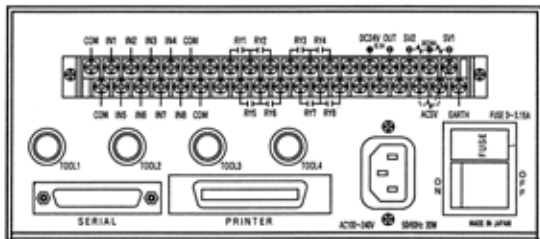

YETC-210



YETC-300



YETC-300

Multi Fastening Controller YETC-210 / YETC-300

The YETC-210/300 are developed for accurate tightening and fit in a Poka Yoka assembly process. The controllers measure, judge, count and document all joints and if necessary, file them in a computer. Communication between the controller and the computer increases the number of facilities. One controller can operate four different impulse wrenches with different specifications (like torque adjustments). By programming different groups for each group of joints, the operator can switch tools without notifying the controller. The controller automatically switches to operate the next tool, after tightening all joints within the group according to the specifications. The controller is available in several executions for all kinds of applications and can be programmed in numerous ways, in relation to the various joints.

Features YETC-210 EA

- Easy to program, according application specifications
- Improved electronics for even more accurate and faster torque calculations
- Torque calculation over more impulses
- Standard 1 tool connection
- Optional 4 tool connection (not to operate at the same time)
- Compensation impulses to minimize relaxation
- Poka Yoke proof (group control, etc.)
- 2-step tightening possible
- Buzzer or LED version tool
- 8 setting groups-
- Parallel and RS-232 output for traceability
- External solenoid valves in air supply
- Integration in the production possible by means of many input- / output signals
- 2-way communication by RS-232
- Automatic group change (sequence programmable)
- Real time clock
- Built in timer (for job)
- More input signals (see manual for details)
- More output signals (see manual for details)
- Can be integrated in the production any thinkable way (input - output signals)
- Statistics inside CP CPK
- Memory for 10.000 cycles

Extra features YETC-210 EA-LAN

- Ethernet (100 BASE-TX/10 BASE-T Autodetect function)
- Protocol: TCP/IP
- Connector: RJ-45

Features YETC-300

- Same functionality and parameters as in YETC-210
- Two tools can be used simultaneously

System wrenches

Documentation of the joint

Yokota has impulse wrenches with an integrated transducer (system wrenches). In combination with a controller YETC-210 / YETC-300 the torque can be set and judged. The measured torque can be stored in a computer or printed. With this system can be shown that the correct joint was made, in case of product liability claims. The systems wrenches only need 1 to 2 seconds for each joint. The tools have no kick back and fit perfectly in a Poka Yoke assembly area.

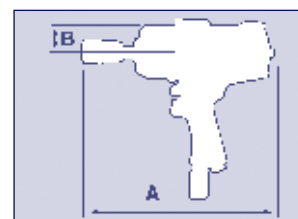
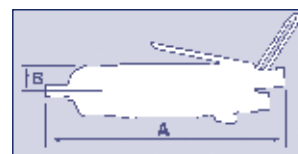

System wrenches with documentation of the joints

Type	Square / Hex drive	Bolt capacity mm	RPM	Torque Nm**	Air consumption l/sec	Weight kg	Inlet thread	Hose diameter mm	Dimensions		Vibration m/s ²	Noise-level dB(A)
									A mm	B mm		
YEX-100SA	3/8" Hex	5	8.000	4.3 - 12	3,6	1,2	PT 1/4"	9,5	285	23	3	77
YEX-120	3/8" Sq.	4 - 5	9.000	13 - 17	4,2	1,43	PT 1/4"	9,5	222	23	3	72
YEX-120A	1/4" Hex	4 - 5	9.000	11 - 15	4,2	1,43	PT 1/4"	9,5	223	23	3	72
YEX-120SA	1/4" 6 Hex	4 - 5	7.000	11 - 15	4,2	1,38	PT 1/4"	9,5	279	23	3	72
YEX-150	3/8" Sq.	5 - 6	9.000	19 - 27	4,2	1,43	PT 1/4"	9,5	222	23	3	72
YEX-150A	1/4" Hex	5 - 6	9.000	14 - 22	4,2	1,43	PT 1/4"	9,5	223	23	3	72
YEX-150S	3/8" Sq.	5 - 6	8.000	19 - 27	4,2	1,35	PT 1/4"	9,5	275	23	3,3	73
YEX-150SA	1/4" Hex	5 - 6	8.000	14 - 22	4,2	1,35	PT 1/4"	9,5	276	23	3,3	73
YEX-300S	3/8" Sq.	6	8.000	25 - 33	5,0	1,8	PT 1/4"	9,5	312	27	5,3	71
YEX-300SA	1/4" Hex	6	8.000	21 - 29	5,0	1,8	PT 1/4"	9,5	313	27	5,3	71
YEX-501	3/8" Sq.	6 - 8	8.200	25 - 52	5,3	2,0	PT 1/4"	9,5	234	26,5	1,6	68
YEX-501A	1/4" Hex	6 - 8	8.200	23 - 49	5,3	2,0	PT 1/4"	9,5	227	26,5	1,6	68
YEX-500S	3/8" Sq.	6 - 8	7.800	23 - 49	5,0	2,1	PT 1/4"	9,5	333	27	6,6	71
YEX-500SA	1/4" Hex	6 - 8	7.800	21 - 47	5,0	2,1	PT 1/4"	9,5	224	27	6,6	71
YEX-700S	3/8" Sq.	8	7.500	33 - 61	5,8	2,3	PT 1/4"	9,5	333	27	6,6	72
YEX-701	3/8" Sq.	8 - 10	8.000	45 - 75	6,7	2,2	PT 1/4"	9,5	246	26,5	1,6	71
YEX-901	1/2" Sq.	10	6.100	61 - 104	6,7	2,7	PT 1/4"	9,5	257	33,5	2,3	73
YEX-1400	1/2" Sq.	10 - 12	5.900	92 - 142	8,3	3,5	PT 1/4"	9,5	266	34	3	80
YEX-1900	1/2" Sq.	12	5.800	115 - 183	8,3	4,1	PT 1/4"	9,5	277	39	3	80
YEX-3000	3/4" Sq.	16	4.000	186 - 284	10,0	6,4	PT 1/4"	12,7	309	40	4	82

Note: All YEX-types are pistol models, with exception of the S and SA types.

** Torque specifications

All specified torques are measured on the Yokota testers, series YET, at a dynamic airpressure of 0.63MPa. The Yokota testers have a static transducer, the specified torques are therefore to be used as a guidance only. In general the torque range will be lower in case of using lower airpressure, extension bars, torx or hexagon inset sockets, soft joints, etc.

Special hose (type YP YEX) for protection of the signal cable minimizes production stops due to cable damage. Applicable on all YEX pistol models. Standard length: 7m (page 19).

Rubber protection covers for system wrenches are included in the box, with exception of the straight models (see page 19).

Accessories for impulse wrenches on pages 18 - 20.

Double chamber air motor

The YED system wrenches are equal to the YEX-series, but with the added feature of a double chamber air motor. The system wrenches with double chamber air motor reach the required torque very quickly. The tools have a high number of impulses per second, and therefore very accurate torques can be realized. On top of that, TKa series have lighter weight, can run on oilfree air and offer best ergonomics. TKa-series can be delivered optionally with LED signalling instead of a buzzer.



Série TKa

YED-240S

System wrenches with double chamber air motor - new lightweight series

Type	Square / Hex drive	Bolt capacity mm	RPM	Torque Nm**	Air consumption l/sec	Weight kg	Inlet thread	Hose diameter mm	Dimensions A mm	B mm	Vibration m/s ²	Noise-level dB(A)
TKa60A	1/4" Hex	6	6.000	11 - 16	4,5	1,3	PT 1/4"	6,5	179	22	2,1	71
TKa70A	1/4" Hex	6 - 8	7.000	20 - 27	5,3	1,3	PT 1/4"	6,5	179	22	2,1	75
TKa80A	1/4" Hex	8	7.000	24 - 33	5,3	1,3	PT 1/4"	6,5	186	22	2,1	73
TKa60	3/8" Sq.	6	6.000	14 - 20	4,5	1,3	PT 1/4"	6,5	179	22	2,1	71
TKa70	3/8" Sq.	6 - 8	7.000	20 - 35	5,3	1,3	PT 1/4"	6,5	179	22	2,1	75
TKa80	3/8" Sq.	8	7.000	32 - 46	5,3	1,3	PT 1/4"	6,5	186	22	2,1	73
TKa90	3/8" Sq.	8 - 10	6.500	47 - 70	6,8	1,5	PT 1/4"	9,5	195	24	2,1	78
TKa110	1/2" Sq.	10 - 12	6.000	65 - 105	8,8	1,9	PT 1/4"	9,5	210	26	2,2	80
TKa120	1/2" Sq.	12	5.900	85 - 130	10	2,4	PT 1/4"	9,5	223	28	2,2	82
TKa140	1/2" Sq.	14	5.200	100 - 160	13	2,9	PT 1/4"	9,5	235	30	2,2	84
TKa150	1/2" Sq.	14 - 16	4.200	150 - 220	13,2	3,4	PT 1/4"	9,5	242	32	2,4	84
YED-200	3/4" Sq.	20	3.400	155 - 360	18,3	6,8	PT 1/2"	12,7	309	40	4,2	86
YED-240S*	1" Sq.	24	3.000	250 - 600	28,3	11,2	PT 1/2"	12,7	452	52,5	15,0	92

* YED-240S is a straight model. ** See torque specifications on page 15.



Optional on TKa System Wrenches: integrated LED status-signal:

- Green = OK
- Re = not OK

Visible from every angle: left, right, from top and behind.

For a system YEX, YED or TKa you need:

- 1 x Controller YETC-210 GTB or YETC-210 EA
- 1 x Impulse wrench YEX, YED or TKa
- 1 x Solenoid valve and tool cable (7m) YETC-2 SVC

Optional equipment:

- For two-step tightening YETC-2ETB SVD
- (2 solenoid valves, 2 air pressure regulators and a tool cable 7m)
- Printer YETC-3P and cable YETC-2PC
- Tool cables: YP7642-0908-01-38, connecting cable, YP7642-1400-00-00 (10m), YP7642-0908-01-19 (15m)
- Lamp tower
- Socket selector box
- Spiral hose with intergrated toolcable, max. 15m (-misc010606).



The transducer for the YEX, YED and TKa

The strain gauges are positioned on the main shaft, picking up the twisting torque on the main shaft at each impulse as close as possible to the socket. The electric signals are transmitted by induction through the internal- and external coils. Due to this principle the Yokota transducer is very reliable, accurate and without wear.

System wrench

Yokota E-wrench



The Yokota E-wrench has been developed on request of the car industry in order to decrease the cost of production. This has been achieved by decreasing the energy consumption. The energy consumption of the E-wrench is only 10% of a comparable air tool. This benefits the environment as well.

Features

- Better ergonomics due to lower noise- and vibration levels, low trigger force and no reaction force
- The E-wrench has a high performance, which results in the same torque accuracy as the YEX/YED/TKa (air) system wrench
- High degree of reliability and safety

In comparison with continuous drive tools:

- Time savings up to 35% possible
- At the same torque level: higher clamp-forces and less relaxation



Type	Square drive	Bolt capacity mm	RPM	Torque Nm*	Spindle offset mm	Weight kg	Noiselevel under load dB(A)
e-M60	3/8" Sq.	6	3.500	10 - 25	23	1,9	73
e-M80	3/8" Sq.	8	3.500	20 - 40	23	2,6	73

* Torque specifications

All specified torques are measured on the Yokota testers, series YET. The Yokota testers have a static transducer, the specified torques are therefore to be used as a guidance only. In general the torque range will be lower in case of using extension bars, torx or hexagon inset sockets, soft joints, etc.

System configuration

Using AC 100 - 240V as power source. Tightening with torque control function. Torque controller is common with YEX-system air operated wrenches. Driver unit is required to drive the motor. Controller (YETC-210/300) and driver unit (e-PDA-2) to be ordered separately.



Accessories

Sleeve drive impact sockets

Sleeve drive impact sockets are developed by Action on demand of Yokota, to improve the quality of tightenings with impulse wrenches. Sleeve drive impact sockets have less play between socket and anvil, thus reducing wobble and increasing the torque repeatability.

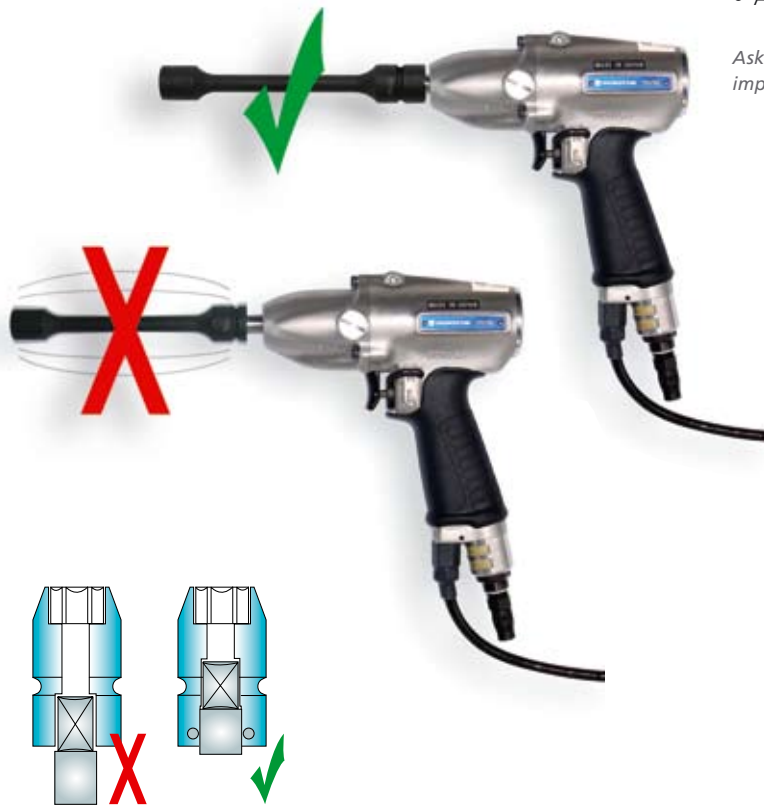

Less Vibration, less noise, less wear and better torque tolerance!

Sleeve drive impact sockets

An overview of our program:

- Hexagon sockets
- Normal or long execution
- Torx ®, internally and externally
- Magnetic executions
- Sockets for internal hexagon boltheads
- 3/8", 1/2" and 3/4" square drive
- Adapters and extensions

Ask for our special brochure on sleeve drive impact sockets.



Quickchange adapters

Accessories

For impulse - & system wrenches

Rubber protection cover



Ordernumber	For type
0089-0029-00-00	YX-180
0081-0029-00-00	YX-280
0086-0029-00-00	YX-380
0077-0029-00-01	YX-500
0129-0029-00-01	YX-700
0237-0029-00-01	YX-900
0241-0029-00-00	YX-1100
0322-0029-00-00	YX-1400
0320-0029-00-00	YX-1900
0406-0029-00-00	YX-2400
0405-0029-00-00	YX-3000

0186-0029-00-00	TKa60
0186-0029-00-00	TKa70
0193-0029-00-00	TKa80
0181-0029-00-00	TKa90
0187-0029-00-00	TKa110
0342-0029-00-00	TKa120
0341-0029-00-00	TKa140
0343-0029-00-00	TKa150
0189-0029-00-00	YLa70
0191-0029-00-00	YLa80
0188-0029-00-00	YLa90
0190-0029-00-00	YLa110

0161-0029-00-00	Y-41
0160-0029-00-00	Y-46
0159-0029-00-00	Y-56
0158-0029-00-00	Y-61
0135-0029-00-00	Y-70
0141-0029-00-00	Y-90
0334-0029-00-00	Y-100
0335-0029-00-00	Y-130
0412-0029-00-00	Y-140
0164-0029-00-00	Y-T45
0164-0029-00-00	Y-T55
0166-0029-00-00	Y-T70
0167-0029-00-00	Y-T90
0409-0029-00-00	YED-200
0093-0029-00-00	YEX-120
0093-0029-00-00	YEX-150
0260-0029-00-00	YEX-501
0143-0029-00-00	YEX-701
0261-0029-00-00	YEX-901
0323-0029-00-00	YEX-1400
0321-0029-00-00	YEX-1900
0407-0029-00-00	YEX-3000



Battery for battery impulse wrenches

Ordernumber	For type	Description
8530-3001-00-01	YBX-1 YBX-50	9,6 V / 2,0 Ah, Type EB-9B, Ni-Cad
8530-3002-00-00	YBX-1 YBX-50	9,6 Volt / 2.0 AH, Type EB-9M, Ni-Cad with LED-indication

Chargers for battery impulse wrenches

Ordernumber	For type	Description
8530-4006-00-00	YBX-1 YBX-50	230 Volt, Type UC24YFA Universal charger

Battery for battery system wrench

Ordernumber	For type	Description
0351-1521-00-99	YBX-600T YBX-600TA YBX-800T YBX-800TA	22,2 V / 1,5 Ah Li-ion, Type BL 22 Temps de charge: 20 minutes

Charge for battery system wrench

Ordernumber	For type	Description
8530-4020-00-99	YBX-600T YBX-600TA YBX-800T YBX-800TA	100 - 240 V, Type BC200 Charging time: 20 minutes

Quickchange couplers 7/16" Hex

Ordernumber	For type
DO9938-0-100	3/8" Square drive
DO9912-0-100	1/2" Square drive

Protection hose

Ordernumber	For type
YP YEX	YEX and YED series

Spiral hose

Ordernumber	For type
MISCO10606	For all system wrenches

Tool holder

Ordernumber	For type
SKK	YX-180 • YX-500 • YXS-500 • Y-40 • Y-61 Y-T45 • Y-T55 • YEF-45 • YEF-55 • YEX-120 YEX-150 • YED-60
SKZ	YX-500S • YX-1400 • YXS-700 • YXS- 1100 Y-70 • Y-90 • Y-130 • Y-T70 • Y-T90 YEF-70 • YEF-90 • YEX-300 • YEX-1400 YBX-50

Accessories

For maintenance and service

Service sets

You will need these service sets with spare parts if you are going to change the oil. For quick service we advise you to use a vacuum pump and oil tank (YEVP-1 + YEVP-1T).

Please note!

Always use oil with the right specifications when changing oil. Only then you will have an optimal tool power and a minimum oil consumption. We recommend NOBP oil for the impulse unit.



Service sets containing:

O-rings, back-up rings and springs for impulse mechanisms required for oil change.

Für Typ	Bestellnummer
YX-80	0095-0991-00-99
YX-180	0089-0991-01-99
YX-280	0089-0991-01-99
YX-380	0086-0991-01-99
YX-500S (C)	0086-0991-01-99
YX-500	0077-0991-02-99
YX-700 (S)	0129-0991-00-99
YX-700C	0281-0991-01-99
YX-900	0237-0991-01-99
YX-1100	0237-0991-01-99
YX-1400	0322-0991-00-99
YX-1900	0320-0991-00-99
YX-2400	0320-0991-00-99
YX-3000	0405-0991-00-99
YX-4500	0722-0991-00-99
YXS-500	0245-0991-00-99
YXS-700	0246-0991-00-99
YXS-900	0243-0991-01-99
YXS-1100	0243-0991-01-99
YXS-1900	0248-0991-00-99

TKa-60	0186-0991-00-99
TKa-70	0186-0991-00-99
TKa-80	0193-0991-00-99
TKa-90	0181-0991-00-99
TKa-110	0187-0991-00-99
TKa-120	0342-0991-00-99
TKa-140	0341-0991-00-99
TKa-150	0304-0991-00-99

Yokota torque measuring equipment (YET-series) is especially designed to check and test the functioning and performance of impulse wrenches. All specified torque figures in this brochure are measured on a Yokota torque tester (YET series), with 0.63 MPa air pressure (dynamic). This is a static torque tester. Torque values may differ with other measuring equipment and/or joints (hard/soft).

Model YET-501C	5 - 50 Nm
Model YET-2001C	20 - 200 Nm
Model YET-5001C	100 - 500 Nm

Für Typ	Bestellnummer
YLa-70	0189-0991-00-99
YLa-80	0191-0991-00-99
YLa-90	0188-0991-00-99
YLa-110	0190-0991-00-99

Y-41	0095-0991-00-99
Y-46	0273-0991-01-99
Y-56	0259-0991-01-99
Y-61	0259-0991-01-99
Y-70	0135-0991-03-99
Y-90	0141-0991-00-99
Y-100	0334-0991-01-99
Y-130	0335-0991-00-99
Y-140	0412-0991-02-09
YBX-1	0259-0991-01-99
YBX-50	0259-0991-01-99
YBX-600T	0189-0991-00-99
YBX-800T	0191-0991-00-99
YED-200	0409-0991-00-99
YED-240S	0411-0991-01-99
YEX-120	0089-0991-01-99
YEX-150	0089-0991-01-99
YEX-300S	0086-0991-01-99
YEX-500S	0077-0991-02-99
YEX-501	0077-0991-02-99
YEX-700S	0143-0991-00-99
YEX-701	0143-0991-00-99
YEX-901	0237-0991-01-99
YEX-1400	0323-0991-00-99
YEX-1900	0320-0991-00-99
YEX-3000	0405-0991-00-99
Y-T40	0169-0991-00-99
Y-T45	0164-0991-02-99
Y-T55	0164-0991-02-99
Y-T70	0166-0991-00-99
Y-T90	0167-0991-01-99



Yokota Hi-tec

High Speed Production + High Quality Tightening

2008-2009